

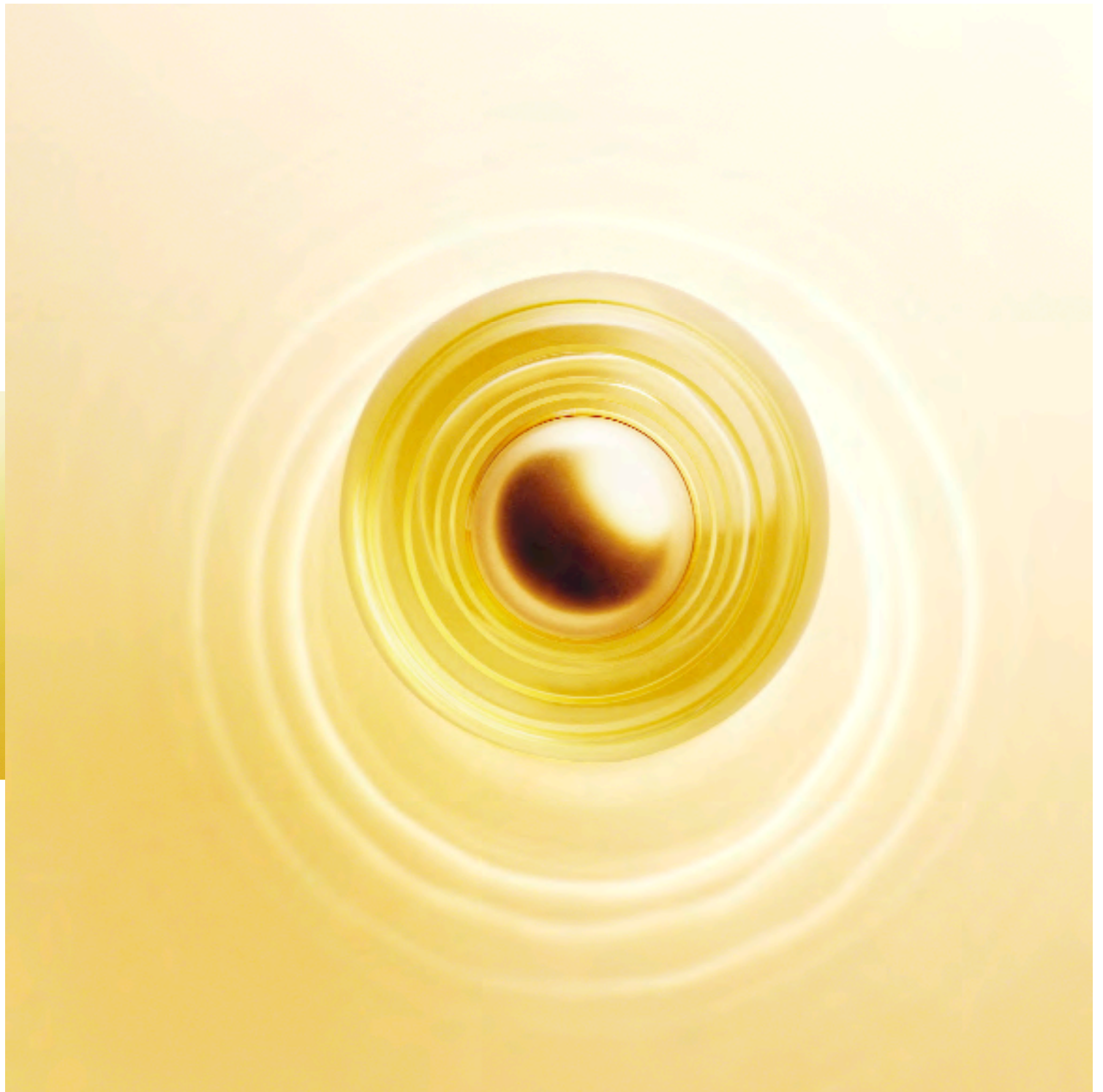

ATTRACTION
PERFUME BOTTLES

MANUFACTURER : LANCÔME.
DESIGN : CHRISTIAN BIECHER,
WITH AGNÈS CAMBUS AND PASCAL SCHALLER.
DESCRIPTION : DESIGN OF THE PERFUME BOTTLES AND CONTAINERS
FOR BODY LOTION, CREAM.
YEAR : 2003.
PHOTOS : LANCÔME.

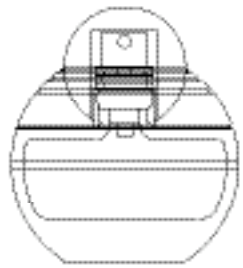



30 ml

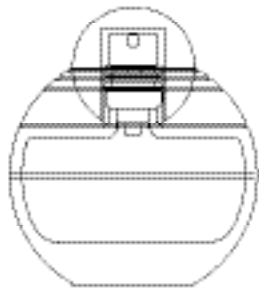

50 ml

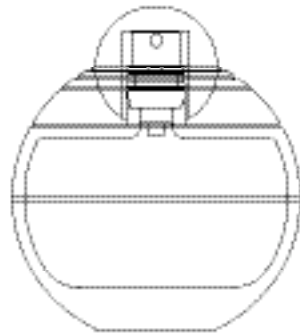
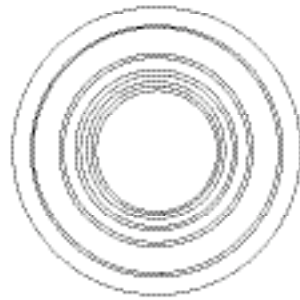

100 ml

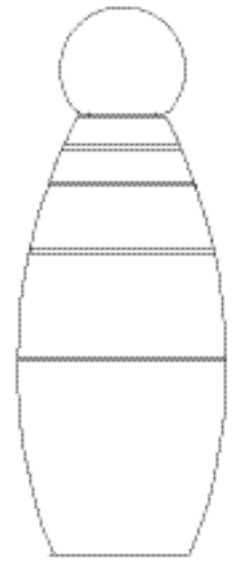
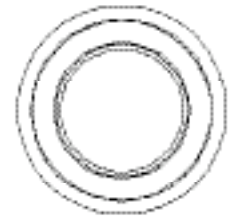
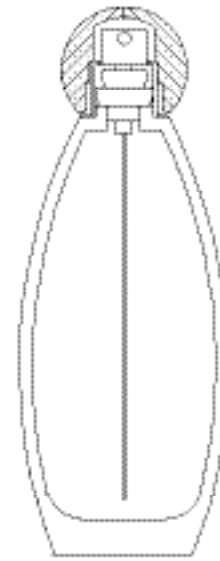

ATTRACTION
PERFUME BOTTLES